



UNIVERSITY OF CAMBRIDGE INTERNATIONAL EXAMINATIONS
International General Certificate of Secondary Education

CANDIDATE NAME

CENTRE NUMBER

CANDIDATE NUMBER

* 3 2 3 8 7 6 7 3 8 3 *

CO-ORDINATED SCIENCES

0654/33

Paper 3 (Extended)

May/June 2010

2 hours

Candidates answer on the Question Paper.

No Additional Materials are required.

READ THESE INSTRUCTIONS FIRST

Write your Centre number, candidate number and name on all the work you hand in.

Write in dark blue or black pen.

You may use a soft pencil for any diagrams, graphs, tables or rough working.

Do not use staples, paper clips, highlighters, glue or correction fluid.

DO NOT WRITE IN ANY BARCODES.

Answer **all** questions.

A copy of the Periodic Table is printed on page 24.

At the end of the examination, fasten all your work securely together.

The number of marks is given in brackets [] at the end of each question or part question.

For Examiner's Use	
1	
2	
3	
4	
5	
6	
7	
8	
9	
Total	

This document consists of **23** printed pages and **1** blank page.



BLANK PAGE

1 (a) Name the proteins that carry out each of the following functions.

(i) transports oxygen inside red blood cells [1]

(ii) reduces the level of glucose in the blood if it goes too high
..... [1]

(iii) catalyses the reaction that breaks down starch to maltose
..... [1]

(iv) attaches to antigens, making it easier for phagocytes to destroy them
..... [1]

(b) When a person eats more protein than can be immediately used in the body, the excess protein is broken down to produce the waste product urea.

(i) Name the organ in which urea is produced. [1]

(ii) Describe how urea is removed from the body. You do **not** need to give any details of what happens in a kidney tubule.
.....
.....
.....
..... [3]

(c) Suggest how a nitrogen atom in a molecule of nitrogen gas in the atmosphere, could become part of a protein in a person's body.

.....
.....
.....
.....
.....
..... [4]

- 2 The industrial electrolysis of concentrated sodium chloride solution (brine) produces important chemicals, **X**, **Y** and **Z**, as shown in Fig. 2.1.

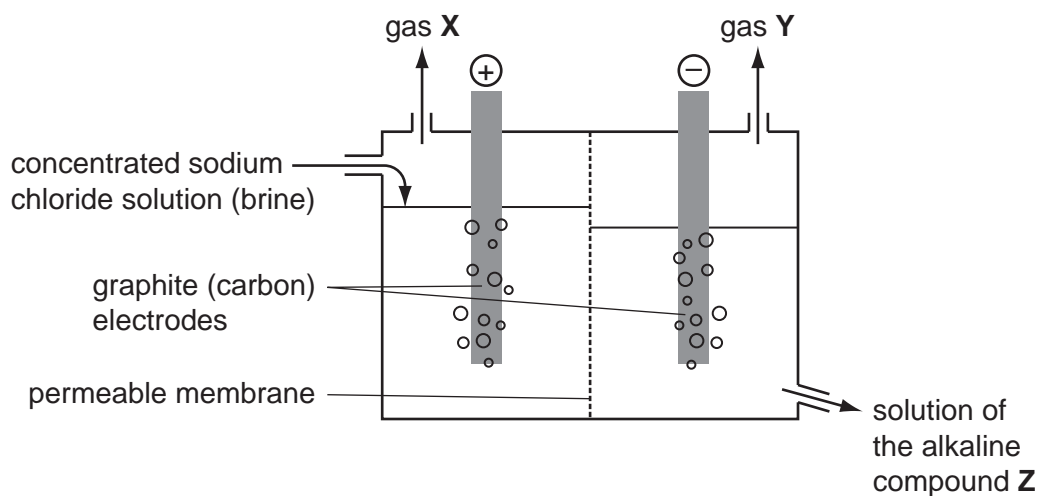

Fig. 2.1

- (a) Write the names or chemical formulae of **X**, **Y** and **Z**.

X

Y

Z

[2]

- (b) Fig. 2.2 shows a diagram of one atom of chlorine.

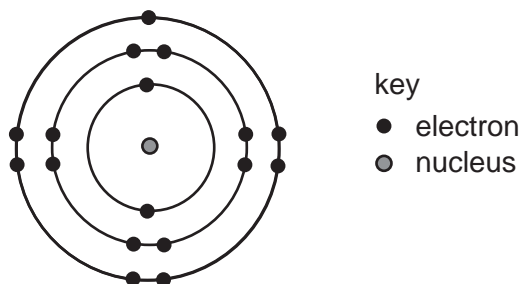

Fig. 2.2

- (i) Every electron has a negative electrical charge.

Explain why the chlorine atom does not have an overall electrical charge.

.....

.....

..... [2]

(ii) Describe, in terms of electrons, what happens when a chlorine atom bonds to an atom of the metallic element potassium. You may wish to draw diagrams to help you answer this question.

.....

.....

.....

..... [3]

- (c) A sweetener such as sucrose, $C_{12}H_{22}O_{11}$, (sugar) is sometimes added to food and drinks to make them taste sweeter.

Sucralose, $C_{12}H_{19}O_8Cl_3$, is a synthetic compound which is used in some other types of sweetener.

Verisweet is a sweetener which contains sucralose mixed with other compounds.

Some information about sucrose and Verisweet is shown in Table 2.1.

Table 2.1

sweetener	mass in a typical spoonful/g	kilojoules per 100 g
sucrose	5.0	1700
Verisweet	0.5	1600

A typical spoonful of Verisweet tastes as sweet as an identical spoonful of sucrose.

- (i) Verisweet contains 1% by mass of sucralose.

Calculate the mass of sucralose in a typical spoonful of Verisweet weighing 0.5g.

..... [1]

- (ii) Use your answer to (i) to calculate the number of moles of sucralose in a typical spoonful of Verisweet.

Show your working.

..... [3]

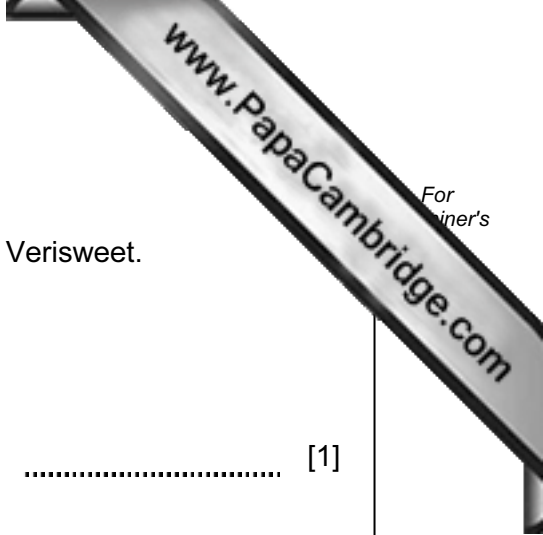

(iii) A typical spoonful of sucrose contains 85 kilojoules.

Calculate the number of kilojoules in a typical spoonful of Verisweet.

..... [1]

(iv) Verisweet is much more expensive than sucrose.

Suggest why some people might choose to use Verisweet rather than sucrose.

.....
.....
.....
..... [2]

3 (a) Describe how heat energy from a nuclear reactor is used to produce electricity.

.....
.....
..... [2]

(b) Describe **two** advantages of a nuclear power station over a coal-burning power station.

1
.....
2
..... [2]

(c) A transformer at a power station steps up the voltage from 25 000 V to 400 000 V.

(i) Use the equation

$$\frac{V_p}{V_s} = \frac{N_p}{N_s}$$

to calculate the number of turns on the primary coil if there are 20 000 turns on the secondary coil.

Show your working.

..... [2]

(ii) Explain why electricity is transmitted at such a high voltage.

.....
.....
..... [2]

(d) One of the waste products formed in nuclear power stations is the isotope strontium-90. Details of this isotope of strontium are:

nucleon (mass) number	90
proton (atomic) number	38
half-life	28.8 years

Strontium-90, like other waste products from nuclear reactors, has been produced by nuclear fission.

(i) State what happens to atoms during nuclear fission.

..... [1]

(ii) Use the information about strontium-90 to work out:

the number of protons in a strontium-90 atom,

the number of neutrons in a strontium-90 atom. [2]

(iii) Strontium-90 decays by beta particle emission.

Use the copy of the Periodic Table on page 24 to deduce the identity of the element formed when strontium-90 atoms decay.

..... [1]

4 (a) Fig. 4.1 shows how light intensity affects the rate of photosynthesis of a plant.

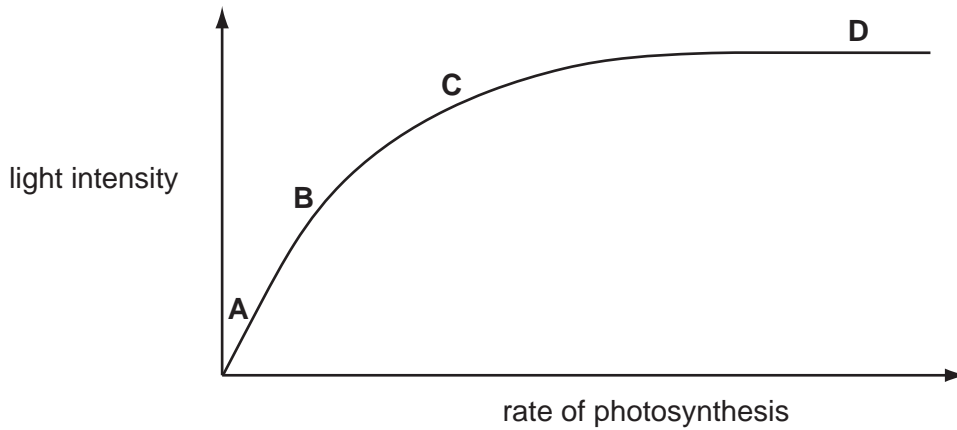

Fig. 4.1

(i) Explain why light is needed for photosynthesis.

.....

 [2]

(ii) Give the letter of the part of the graph in which light intensity is **not** limiting the rate of photosynthesis.

..... [1]

(b) The diagrams in Fig. 4.2 show sections through two leaves on the same tree. The two diagrams are drawn to the same scale. The contents of the cells are not shown.

Leaf **A** was taken from a part of the tree that was always in shade.
 Leaf **B** was taken from a part of the tree that received plenty of sunlight.

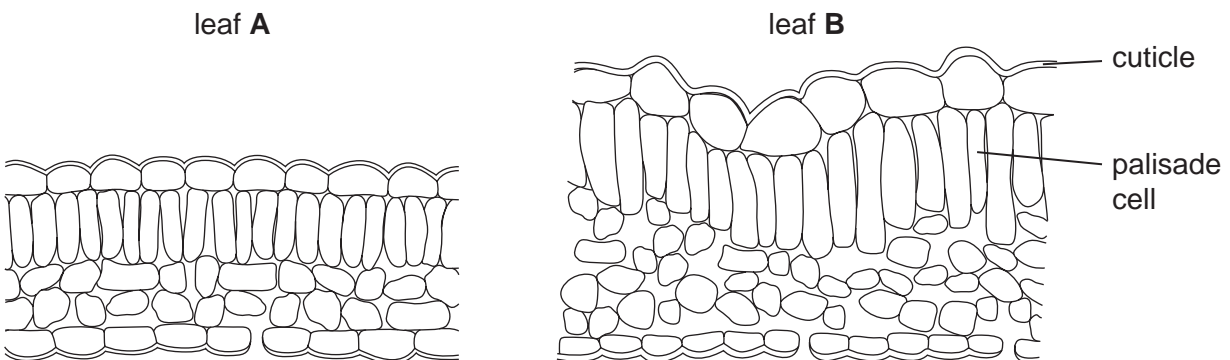

Fig. 4.2

(i) Leaf **B** has larger palisade cells than leaf **A**.

Suggest an advantage of this to the tree.

.....
.....
..... [2]

(ii) Describe **two** ways, other than the size of the palisade cells, in which leaf **B** differs from leaf **A**.

1
.....
2
..... [2]

(iii) Describe how carbon dioxide travels to a palisade cell in a leaf.

.....
.....
.....
..... [3]

(c) The differences between leaf **A** and leaf **B** are an example of variation.

State whether this variation is caused by

- genes,
- the environment,
- both genes and environment together.

Explain your answer.

cause of variation

explanation

..... [2]

- 5 (a) Solutions of substances in water are acidic, neutral or alkaline.

Choose pH values from the list to complete Table 5.1.

list of pH values 2 5 7 9 13

Table 5.1

liquid	description	pH
sodium chloride solution	neutral	
acid rain	weakly acidic	

[2]

- (b) A student used the apparatus shown in Fig. 5.1 to investigate the reaction between dilute hydrochloric acid and magnesium.

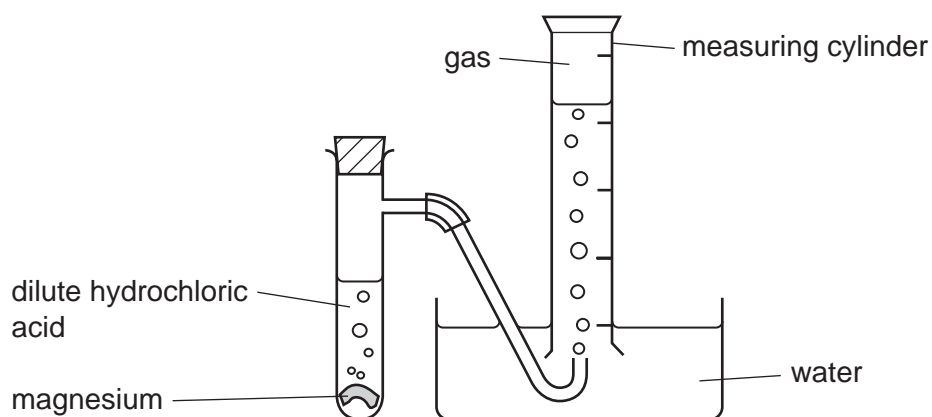

Fig. 5.1

- At the start of the experiment, the inverted measuring cylinder was full of water.
- The student started the reaction by dropping a weighed piece of magnesium into a known volume of dilute hydrochloric acid.
- She replaced the bung and started a stopwatch.
- She recorded the time taken for gas to collect in the inverted measuring cylinder.
- Her results are shown as a graph in Fig. 5.2.

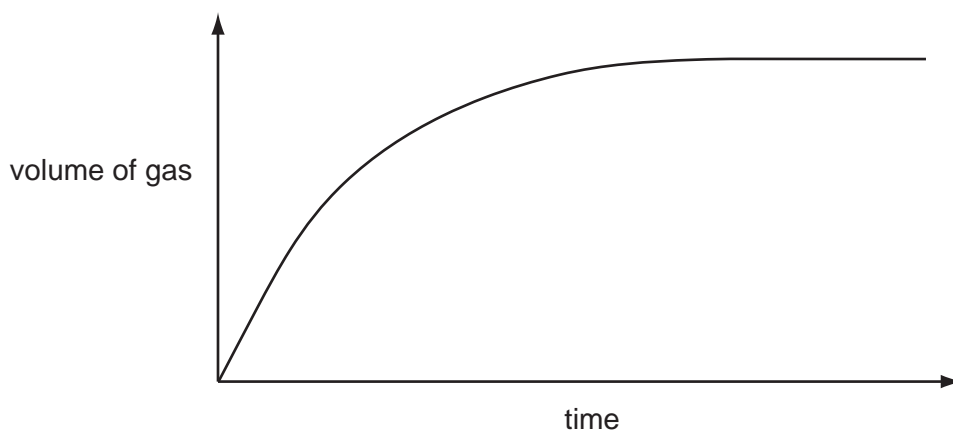

Fig. 5.2

- (i) Write a balanced symbolic equation for the reaction between magnesium and dilute hydrochloric acid.

..... [3]

- (ii) Explain, in terms of collisions between particles, why the rate of the reaction is greatest near the beginning, and then slows down.

.....

..... [3]

- (iii) The student carried out a second experiment in which she used dilute hydrochloric acid that had a higher temperature. She kept all of the other reaction conditions the same as in the first experiment.

On the graph in Fig. 5.2, sketch a line which the student might obtain when she plots the results of this second experiment. [2]

6 (a) (i) A block of metal has a mass of 720 g and a volume of 80 cm³.

Calculate the density of the block.

State the formula that you use and show your working.

formula

working

..... [2]

(ii) The block has a specific heating capacity of 400 J/kg °C. It is heated and the temperature rises by 50 °C.

Calculate the minimum amount of energy required to do this.

State the formula that you use and show your working.

formula

working

..... [3]

(iii) A force of 100 N acts on this block.

Calculate the acceleration of the block.

State the formula that you use and show your working.

formula

working

..... [2]

(b) A student tested the block to see if it conducted electricity.

Draw a simple circuit which the student could build for this purpose. Use the correct circuit symbols.

[2]

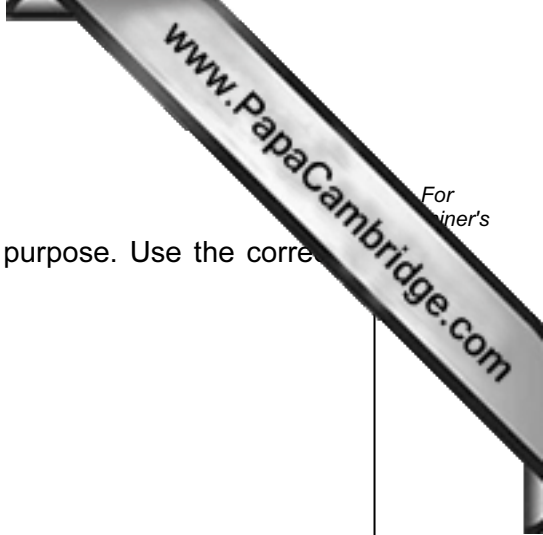

For
inert's

7 (a) Fig. 7.1 shows a motor neurone.

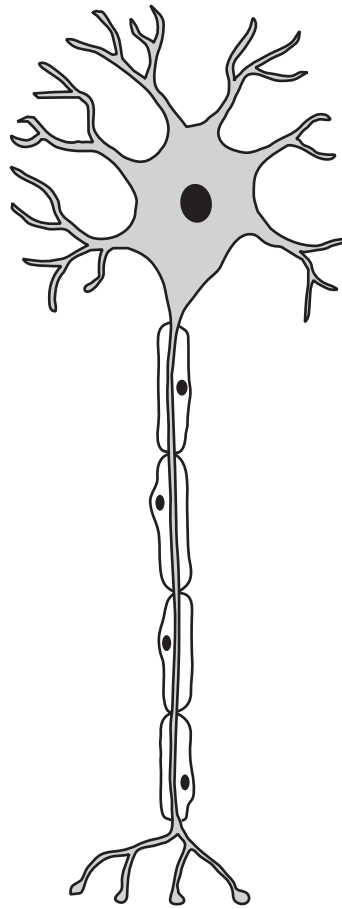

Fig. 7.1

(i) Use a label line and the appropriate letter to label each of these structures:

A axon,

B nucleus of neurone.

[2]

(ii) A motor neurone may be part of a reflex arc.

Describe the role of a motor neurone in a reflex arc.

.....

.....

.....

..... [3]

(b) Sprinters need fast reflexes to make a good start in a 100 m race. The time between the starting gun being fired and the runner pushing off from the starting blocks is known as the reaction time.

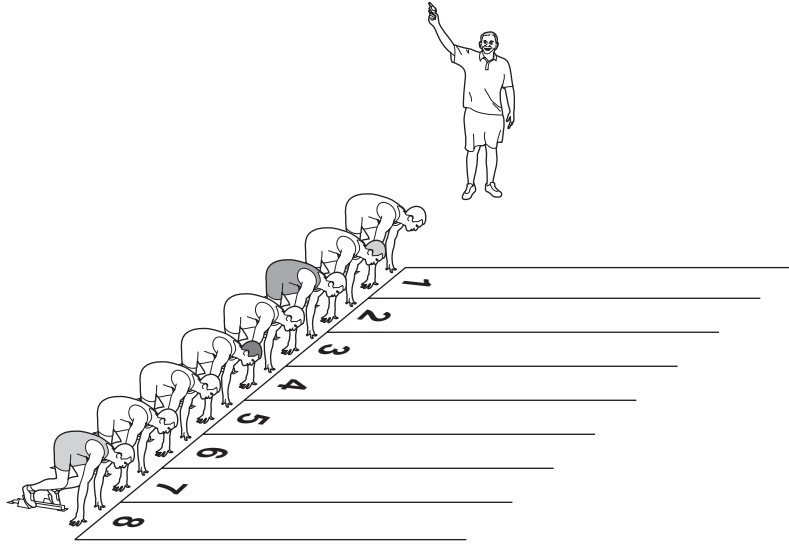

Fig. 7.2

The reaction time is made up of:

- the time taken for the sound from the starting gun to reach the runner's ear,
- plus the time taken for a nerve impulse to pass from the ear to the brain,
- plus the time taken for a nerve impulse to pass from the brain to the leg muscles.

(i) A runner in lane 1 is 2 m from the starting gun. Sound travels at 330 m/s.

Calculate the time taken for the sound to reach the runner's ear.

Show your working.

..... [2]

Table 7.1 shows the reaction times of the runners in lane 1 and lane 8 in the (qualifying races) for a 100m race.

Table 7.1

	reaction time / s							
	heat 1	heat 2	heat 3	heat 4	heat 5	heat 6	heat 7	heat 8
lane 1	0.133	0.146	0.170	0.160	0.186	0.176	0.149	0.147
lane 8	0.228	0.223	0.188	0.195	0.178	0.199	0.163	0.167

(ii) Draw a ring around the heat that shows anomalous results. [1]

(iii) Describe the relationship between the reaction time and the lane.

Use your answer to (b)(i) to suggest an explanation for this relationship.

relationship

.....

explanation

..... [2]

(c) Nerve impulses pass along neurones from the brain to the leg muscles at about 70 m/s.

Suggest whether this is likely to produce a significant difference between the reaction times of a runner who is 1.9m tall and a runner who is 1.6 m tall.

Explain your answer.

.....

.....

..... [2]

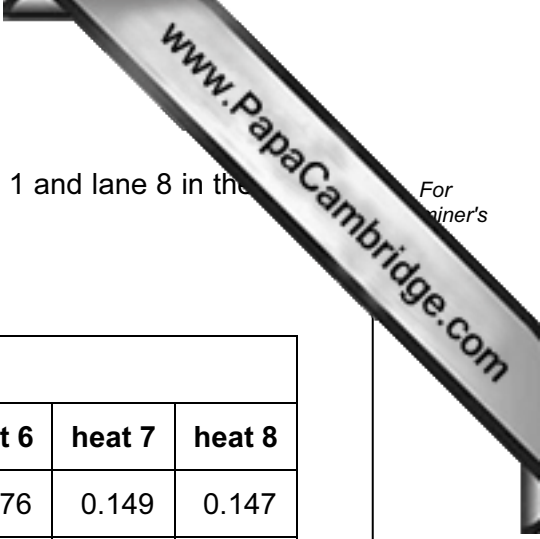

8 (a) A racing car is being driven in a race.

The graph in Fig. 8.1 shows the speed of the car over a 26 second period.

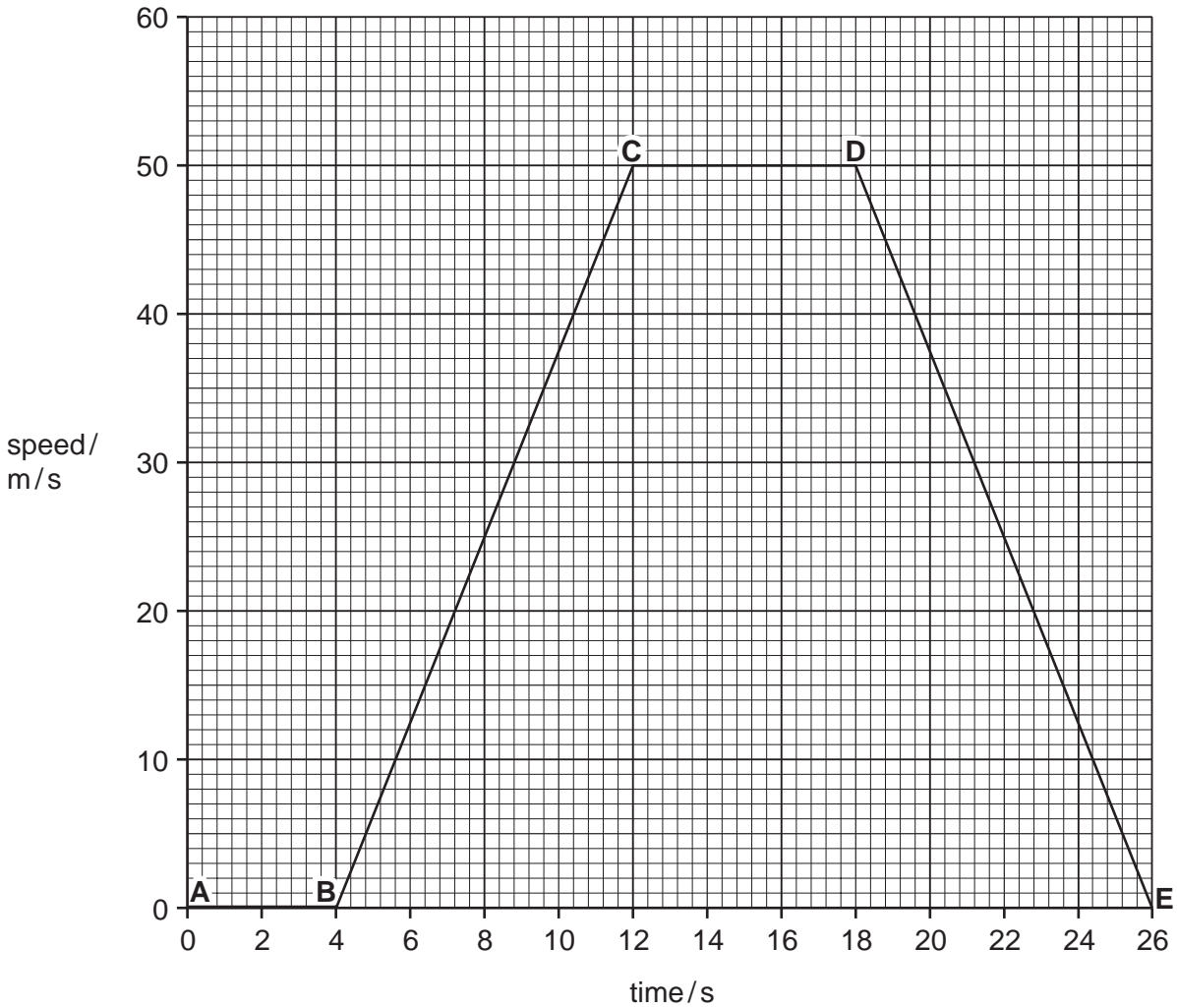

Fig. 8.1

(i) Between which points on the graph is the car not moving?

..... [1]

(ii) Calculate the acceleration of the car between B and C.

Show your working.

..... [2]

(b) A wheel on a car needs changing. Fig. 8.2 shows a spanner being used to turn a nut.

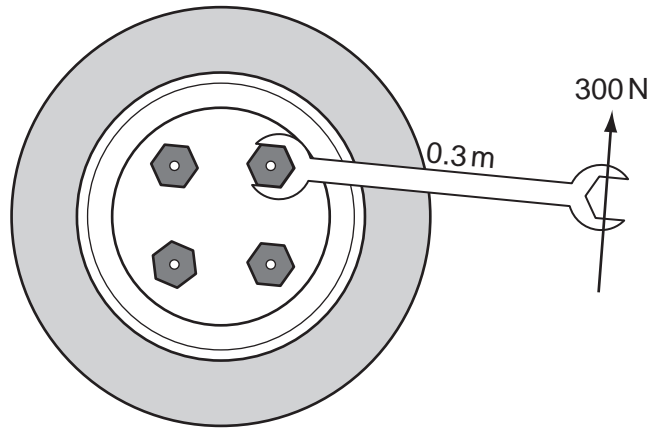

Fig. 8.2

(i) Calculate the turning effect (moment) of the spanner.

State the formula that you use and show your working.

formula

working

..... [2]

(ii) Give **two** ways in which you could increase the spanner's turning effect.

1

.....

2

..... [2]

- (c) During a race the air in the tyre is at a temperature of 400 K and a pressure of $120\,000\text{ N/m}^2$. After the race, the air in the tyre cools down to a temperature of 300 K. For
inner's

Calculate the new air pressure in the tyre.

State the formula that you use and show your working.

formula

working

..... [3]

9 Fig. 9.1 shows part of the water cycle.

Arrow **Q** shows where rain is falling. The rainwater collects in streams and rivers which flow over rocks in the Earth's crust.

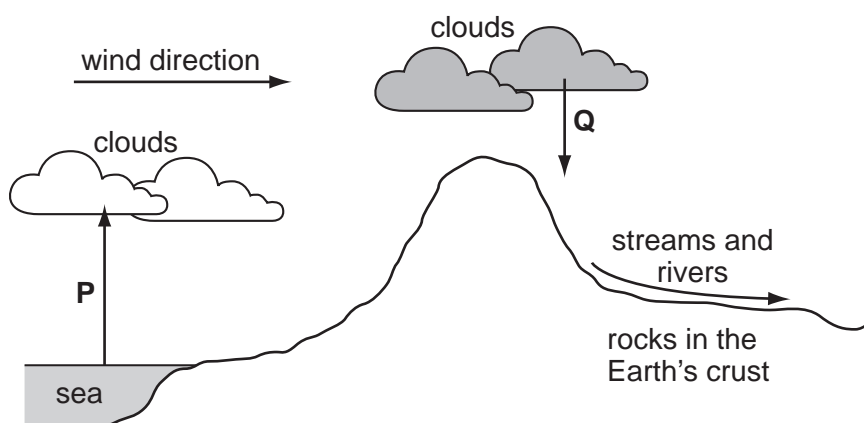

Fig. 9.1

(a) Describe the processes which are represented by arrow **P** in Fig. 9.1.

.....

.....

..... [2]

(b) Water molecules contain the elements hydrogen and oxygen.

Complete the bonding diagram below to show

- the chemical symbols of the elements in a molecule of water,
- the arrangement of the outer electrons of each atom.

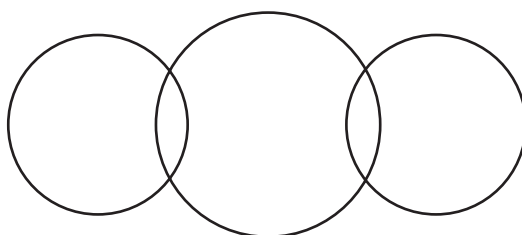

[2]

(c) Fig. 9.2 shows a simplified diagram of a machine for washing dishes (dishwasher) which is used in a hard water area.

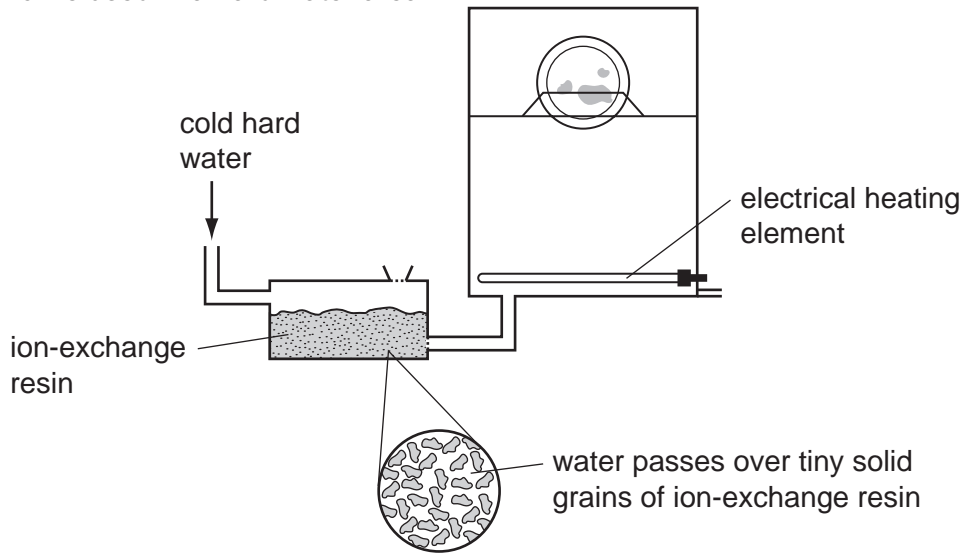

Fig. 9.2

In this machine, the water which is to be used to clean the dishes is first passed through an ion-exchange resin. The water is then heated to a high temperature by the electrical heating element.

(i) One type of hardness in water may be removed simply by boiling.

State the name or chemical formula of the compound which causes this type of hardness.

..... [1]

(ii) Describe, in terms of ions, what happens when the cold hard water flows through the ion-exchange resin.

.....
.....
..... [2]

(iii) Explain why it is important that the water passes through the ion-exchange resin before it enters the dishwasher.

.....
.....
..... [2]

